



HEIDENHAIN

Klartext

The TNC Newsletter



**New Features of
the iTNC**



**Position Measure-
ment on Machine
Tools**



**Slimmed-Down
Probe—The New
TS 440**



Issue 43 • 5/2005

Editorial

Dear Klartext Reader,

This industry is steadily increasing its demands on machine tool performance. Constantly changing lot sizes, small quantities and growing requirements for accuracy necessitate short machining times and high machine availability. At the same time, positioning accuracy and control response are gaining significance. To find out why it is important to find the right feedback devices for your applications, look into our article on page 9.

There's a new face among the 3-D touch probe systems. Read on page 12 how the new TS 440 provides 3-D touch probe convenience in a very compact design.

The results of active synergism of schools and industry are explained in our report on CNC instruction in a German college-preparatory school.

And besides an interesting user report from the successful tool-and-die making company Schweiger GmbH, this issue also reveals new features of the TNC and provides news from our Technical Training department.







So read and enjoy! We at Klartext are convinced you'll be glad you did.



page 12

Contents



	New User Functions for the iTNC 530	4
	With HEIDENHAIN Control to the HSM Award	6
	Making Accuracy Happen: Linear Encoders on Machine Tools	9
	New 3-D Infrared TS 440 Touch Probe in Ultra-Compact Design	12
	What Does Building a Fiddle Have to Do with CNC Technology?	14
	HEIDENHAIN Training Network Expanded	15

Imprint

Publisher

DR. JOHANNES HEIDENHAIN GmbH
 Postfach 1260
 D-83292 Traunreut
 Tel: (0 86 69) 31-0
www.heidenhain.de
info@heidenhain.de

Editor

Frank Muthmann

Klartext on the Internet

www.heidenhain.de/e0.htm
 "Documentation"

Layout and Design

Expert Communication GmbH
 Inselkammerstraße 5
 82008 Unterhaching/München
 Tel: (0 89) 66 63 75 0
info@expert-communication.de
www.expert-communication.de

New User Functions for the iTNC 530



In November, HEIDENHAIN released its new smarT.NC software for the iTNC 530 (see Klartext 42). This software requires the new MC 422B hardware which, besides a faster processor, also features more memory. The actual highlight of this software, the new smarT.NC alternative operating mode, is complemented by the following new user functions:

Hardware improvements

- Now you can connect an external mouse to the USB 2.0 interface of the single-processor version and use it to operate smarT.NC and all soft keys.
- The new MC 422B with the new software version 340 49x-xx provide **24 GB of memory** for NC programs.
- HEIDENHAIN places great value on the opinion of its TNC users. As a response to customers' wishes, the cursor block is back in a distinct location on the new TE 530B keyboard. The keyboard also provides new navigation keys for smarT.NC, and the SPEC FCT key now gives you faster access to special functions of the iTNC (for example the PLANE function).

Q parameter programming

The substantially increased number of available Q parameters considerably simplifies an experienced Q parameter programmer's job. It eliminates bottlenecks when writing complex programs. The TNC now provides globally effective parameters from Q0 to Q1999.



262



263



264



265



200



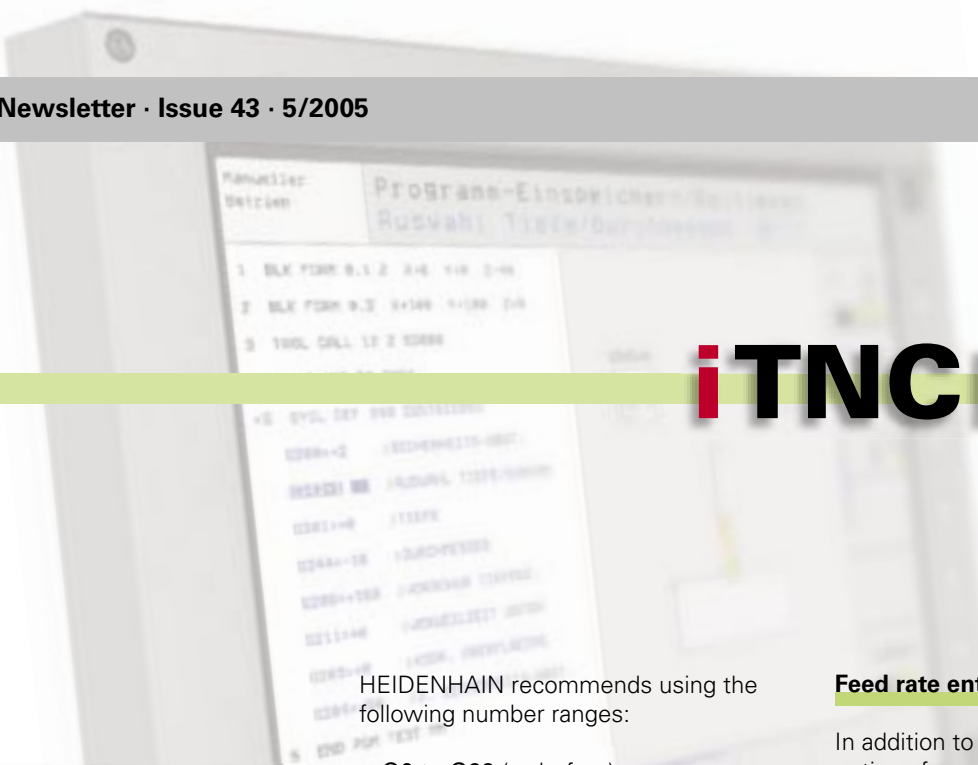

iTNC 530

HEIDENHAIN recommends using the following number ranges:

- Q0 to Q99 (as before): Globally effective parameters
- Q200 to Q1399: Parameters reserved for HEIDENHAIN cycles
- Q1400 to Q1599: Parameters reserved for OEM cycles
- Q1600 to Q1999: Freely available parameters, globally effective

Subprograms/program section repeats

The number of available label numbers was quadrupled so you can now use 1000 labels (LBL 0 to LBL 999). It is also possible to assign label names. You can use label names in addition to the 1000 available label numbers, and the number of usable label names is unlimited. Of course, label names can also be used with Q parameter jump functions FN 9 to FN 12.

Feed rate entry

In addition to the previously available options for entering a feed rate, now you can also enter the tooth feed rate f_z (for cutters) or the revolution feed rate f_u (for drills and boring bars). You can define the following types of feed rate:

- F: feed rate in mm/min (standard setting)
- FMAX: Rapid traverse
- FAUTO: Feed rate as defined in the TOOL CALL block
- FT: Time in seconds in which the programmed path is to be traversed (only for block in which programmed)
- FU: Revolution feed rate in mm per spindle revolution
- FZ: Tooth feed rate in mm/tooth

Editor

Many customers have asked for changes in the block copying function. Up to now, the inserted block remained marked and the user had to use a soft key to unmark it. Now, copying works just as it does for the TNC 426/TNC 430: After insertion, the inserted block automatically loses its marking.

New Centering Cycle

The Centering Cycle 240 is a new addition to the drilling cycles. With this cycle you can define a centering diameter instead of a depth. The iTNC then calculates the depth using the tool point angle defined in the tool table.



New Centering Cycle



With HEIDENHAIN Control to the HSM Award

In the Alpine highlands, uphill paths are steep and rewarding, especially for the Schweiger GmbH company in Uffing on Lake Staffelsee. Motivated, competent people, smart investments, fast and dependable processes, powerful machines and reliable controls have contributed to continuous growth from a one-man operation in 1962 to an exemplary mold making company today. An expression of this excellence is the European High Speed Machining Award 2004 (HSM Award) and outstanding honors in the benchmark competitions of the Fraunhofer Institute for Production Technology and the Machine Tool Laboratory of the RWTH Technical University in Aachen. Some share of this success can certainly be credited to a control system that contributes to the company's great flexibility and speed: HEIDENHAIN numerical controls.

The mold making company on idyllic Lake Staffelsee outstripped all its competitors for the HSM Award. A clever combination of machining strategy and application of the capabilities of machine and control enabled Schweiger to master the balancing act between speed and utmost precision. At roughing, for example, the Uffingers were twice as fast as their nearest competitor. Speed with absolute accuracy, these are two very important parameters for market success as a manufacturer of die-casting tools—and it is the bridge to HEIDENHAIN.

Founded in 1962 and equipped with a single lathe, the company now employs almost 60 specialists. The Uffing plant produces high-quality die-casting tools with dimensions of up to 2000 x 1200 x 1200 mm weighing anywhere from one

to 18 metric tons for technically demanding parts. Well-known auto manufacturers and their vendors are important customers.

The new building, where production started in 2000, houses machinery and equipment that are seldom found in a mold making company of this size. Two to three shifts operate two 5-axis HSC double-column milling machine, diverse machining centers, CNC surface grinding machines, CNC deep-hole drilling machines, and state-of-the-art ram and wire electrical discharge machines.

With approximately 2,500 m², the facility also houses its own hardening shop and two 500 to 1,000-metric-ton plastic injection-molding machines. Its own CNC measuring machine enables Schweiger to also produce the First Article Inspection Report (FAIR).

Thanks to this production test under actual use, the company can offer a form that is immediately ready for series

production. This ensures as risk-free and on-time production start.

The capability of offering a complete one-stop solution from the drawing to the sample makes the mold maker less dependent on upstream suppliers. In addition, Schweiger's plastic processing know-how flows into the development of their molds and helps to increase mold service life. All of this improves production reliability, saves time, and increases productivity.

Extensive experience with HEIDENHAIN

Even Erich Schweiger, the founder of the company, bet on machine tools with dialog-guided controls. By now a long relationship with HEIDENHAIN has developed. Anton Schweiger, who now runs the company together with his father, reports that he now has practically all generations of TNCs in use. The TNC 135 was followed by the TNC 355, TNC 426 and finally the current iTNC 530.





When used for their intended applications, HEIDENHAIN controls that have been working for over 20 years are now just as efficient as ever in tool and die making companies. However, Schweiger mold makers now only use the 426 series and the iTNC 530. The 426 was even retrofitted, for example, to a deep-drilling center as part of its modernization.

Whenever a new machine tool came into consideration, everyone agreed on one thing right at the start—that it would be a HEIDENHAIN control. After all, working with plain language user interfaces has long been second nature to all the skilled specialists in production, and no one wanted to do without the capability

of programming holes, ruled geometries or simple pockets directly at the machine. Nobody at Schweiger wanted to reduce a highly qualified team of machinists to a role of just following orders. In the long run the company needs all its people to think for themselves.

Programmer friendliness

Nevertheless, the programmers also profit from the new features of the iTNC 530. Fast editing and testing, quick mid-program startup, faster data access even in large programs, and generous graphical aids give them confidence and save time. A typical example is the cylinder-surface machining: the user programs contours on cylindrical surfaces by using straight lines and circles as if they were in a plane, that

is, as if the cylinder surface has been unrolled. The control then uses rotary tables to run the operation on the surface of the cylinder. It is also very easy to write programs for making contours and holes on slanted or cylindrical surfaces using machine tools with swivel heads. The operation is programmed as usual in the working plane, for example in X/Y. The control then takes care of the rest, meaning the path control.

A manual is hardly necessary

Anton Schweiger mentions another important criterion for his „loyalty.“ Even if a brand-new machine is installed in the workshop—his employees very seldom need the control manual. The TNCs’

basic features are consistent over all model generations, and the user interface is easy to understand. “If someone can operate one of the HEIDENHAIN controls, he’ll find his way in an older or newer model, too. Our highly skilled machinists had no problem changing from the HEIDENHAIN TNC 426 to the iTNC 530 in just a few days without needing any external training!”

Of course, another positive point is that even old programs still run on the latest control generations.

Machine tool networking via Ethernet

Of course, the 3-D programs at Schweiger are on the server. The machine users get the data in neutral format from the server. A special CAM program converts it into the required machine-specific control program. This solution has proven itself for years at Schweiger.

At any rate, the CAM software enables Schweiger to very flexibly select the machine for an NC program and can optimize capacity management on very short notice. Schweiger uses Ethernet, a nonproprietary technology commonly used in the industry that enables fast data transmission in a Local Area Network (LAN).

iTNC 530: Very fast, very productive

A Fast Ethernet interface and LAN are or no help if the control itself can’t take advantage of their speed. “We notice a very definite increase in speed, for example from the switch from the TNC 426 to the iTNC 530: We have to machine many large contours. Our controls often run part-milling programs of 200 MB, for example, sometimes with over 1.5 million program blocks.

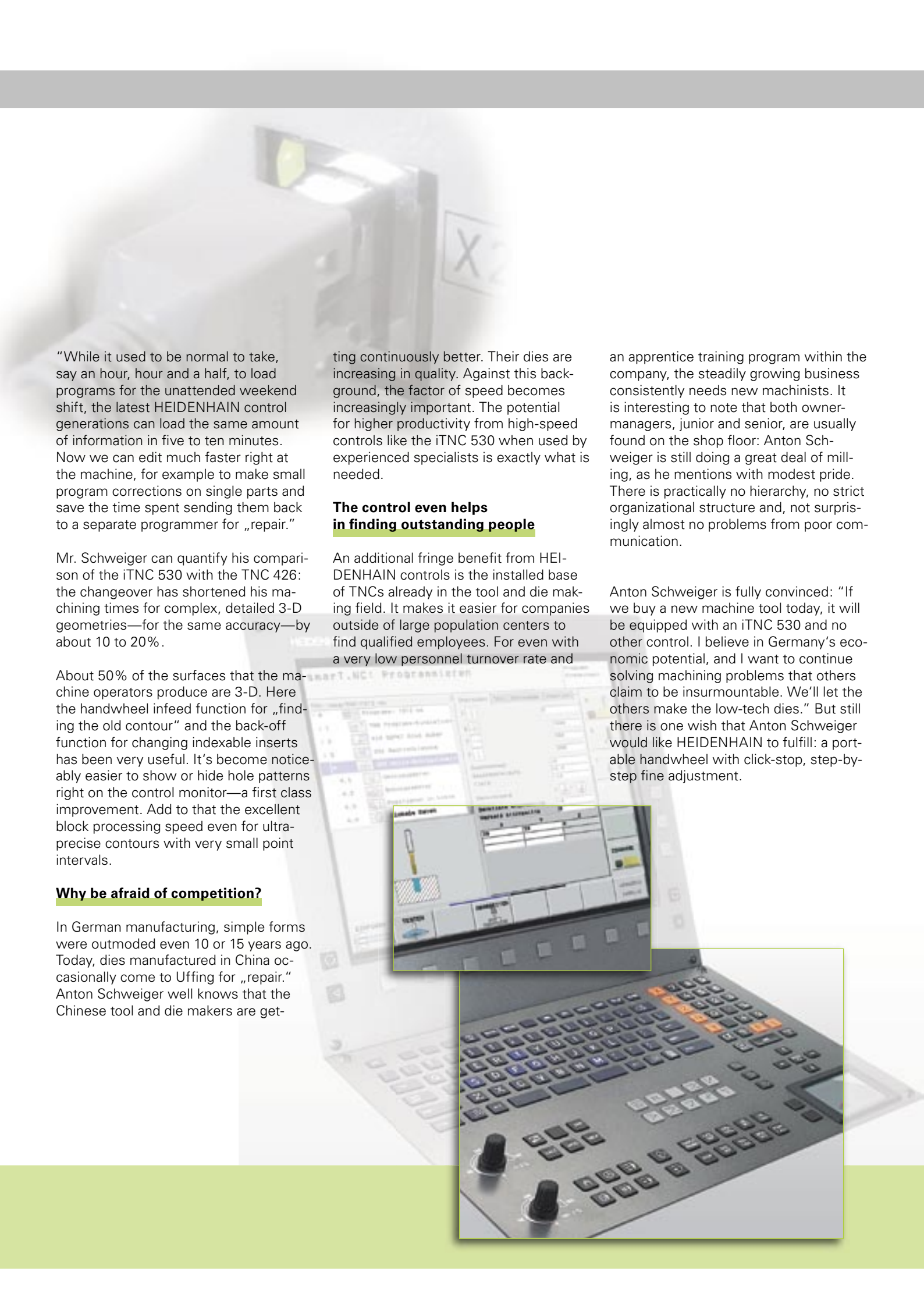

“While it used to be normal to take, say an hour, hour and a half, to load programs for the unattended weekend shift, the latest HEIDENHAIN control generations can load the same amount of information in five to ten minutes. Now we can edit much faster right at the machine, for example to make small program corrections on single parts and save the time spent sending them back to a separate programmer for „repair.”

Mr. Schweiger can quantify his comparison of the iTNC 530 with the TNC 426: the changeover has shortened his machining times for complex, detailed 3-D geometries—for the same accuracy—by about 10 to 20%.

About 50% of the surfaces that the machine operators produce are 3-D. Here the handwheel infeed function for „finding the old contour” and the back-off function for changing indexable inserts has been very useful. It’s become noticeably easier to show or hide hole patterns right on the control monitor—a first class improvement. Add to that the excellent block processing speed even for ultra-precise contours with very small point intervals.

Why be afraid of competition?

In German manufacturing, simple forms were outmoded even 10 or 15 years ago. Today, dies manufactured in China occasionally come to Uffing for „repair.” Anton Schweiger well knows that the Chinese tool and die makers are get-

ting continuously better. Their dies are increasing in quality. Against this background, the factor of speed becomes increasingly important. The potential for higher productivity from high-speed controls like the iTNC 530 when used by experienced specialists is exactly what is needed.

The control even helps in finding outstanding people

An additional fringe benefit from HEIDENHAIN controls is the installed base of TNCs already in the tool and die making field. It makes it easier for companies outside of large population centers to find qualified employees. For even with a very low personnel turnover rate and

an apprentice training program within the company, the steadily growing business consistently needs new machinists. It is interesting to note that both owner-managers, junior and senior, are usually found on the shop floor: Anton Schweiger is still doing a great deal of milling, as he mentions with modest pride. There is practically no hierarchy, no strict organizational structure and, not surprisingly almost no problems from poor communication.

Anton Schweiger is fully convinced: “If we buy a new machine tool today, it will be equipped with an iTNC 530 and no other control. I believe in Germany’s economic potential, and I want to continue solving machining problems that others claim to be insurmountable. We’ll let the others make the low-tech dies.” But still there is one wish that Anton Schweiger would like HEIDENHAIN to fulfill: a portable handwheel with click-stop, step-by-step fine adjustment.



Making Accuracy Happen: Linear Encoders on Machine Tools

This industry is steadily increasing its demands on machine tool performance. The accuracy of the first workpiece is becoming ever more important as batch sizes constantly change with ever smaller quantities and tight lead times. This requires reproducible accuracy, short machining times and high machine availability. Meeting these stringent requirements calls for static and dynamic rigidity of the machine and excellent performance from the TNC control, but in particular for high positioning accuracy and fast control response from the feed axes. It is exactly these aspects that can be significantly improved by choosing suitable position encoders.

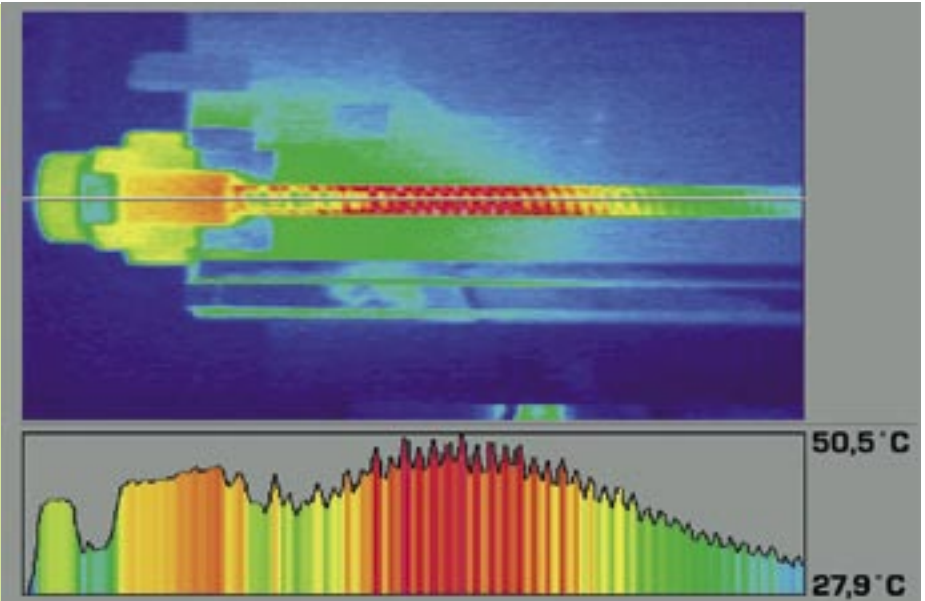

Local heating of a ball screw in the traverse range of the ball nut after 6 hours of reciprocating traverse at 24 m/min between two positions separated by 150 mm.

To meet these critical demands, HEIDENHAIN has introduced a new generation of linear encoders that feature a completely new scanning module along with several other improvements: the LC 481 and LC 182.

Feed system with position measurement via linear encoder

Measuring the slide position with a linear encoder is frequently referred to as the „direct“ measuring method, or—more accurately—the „closed-loop“ method. Linear encoders measure table movements directly. Therefore, play and inaccuracies in the transfer elements of the machine have no influence on the accuracy of the position measurement. This means that the accuracy of measurement depends almost solely on the precision and location of the linear encoder. Sealed linear encoders are protected from dust, chips and splash fluids and are ideal for operation on machines tools

and manufacturing plants. And to increase workpiece accuracy, the encoder should always be located as near as possible to the measured motion. In addition to absolute accuracy on workpieces, the surface definition is a prominent criterion for appraising a machine tool. Here the reproducibility and position stability are particularly important for control response. Good surface definition requires optical linear encoders with small signal periods of 20 microns to as fine as 4 micrometers and with optimal signal quality. This high signal quality must be produced with high quality components, not



Quality of a milled workpiece surface manufactured with different degrees of signal quality.

- A: Linear encoder with an error of $\pm 0.4 \mu\text{m}$ within the signal period (LC481)
- B, C: Linear encoder with an error of $\pm 1 \mu\text{m}$ within the signal period (LC481)



simulated by electronic means, and must not deteriorate over the service life of the machine. Synthetically generated signal periods, on the other hand, are usually optimized only in their amplitude. The fundamental errors, however, remain and become visible on the workpiece.

Sealed linear encoders with the new single-field scanning

With a fundamental revision of its absolute linear encoders, HEIDENHAIN is meeting market demand for significantly better signal quality and increased tolerance to contamination. The newly developed single-field scanning applies to selected sealed linear encoders a principle that is characterized in equal measure by significantly reduced sensitivity to contamination, higher positioning accuracy, higher traversing velocity, and higher signal quality for improved control-loop performance.

Signal generation

The scanning reticle has one large-area grating whose grating period differs slightly from that of the scale. This generates an optical beat along the length of the scanning field: at some positions the lines coincide and let the light through. At other locations the lines and gaps coincide, causing a shadow. In between, the gaps are only partially covered. This causes a type of optical filtering that allows homogenous signals of a shape very close to a sine wave. Instead of individual photovoltaic cells, one large-area, specially structured photosensor generates the four 90° electrically phase-shifted scanning signals.

Insensitive to contamination

The large scanning area over the entire width of the scale grating and the arrangement of several scanning fields in succession make the encoders with single-field scanning extremely insensitive to contamination.

The results of corresponding contamination tests prove this: even when contamination over large areas is simulated, the encoder continues to provide high-quality signals. The position error

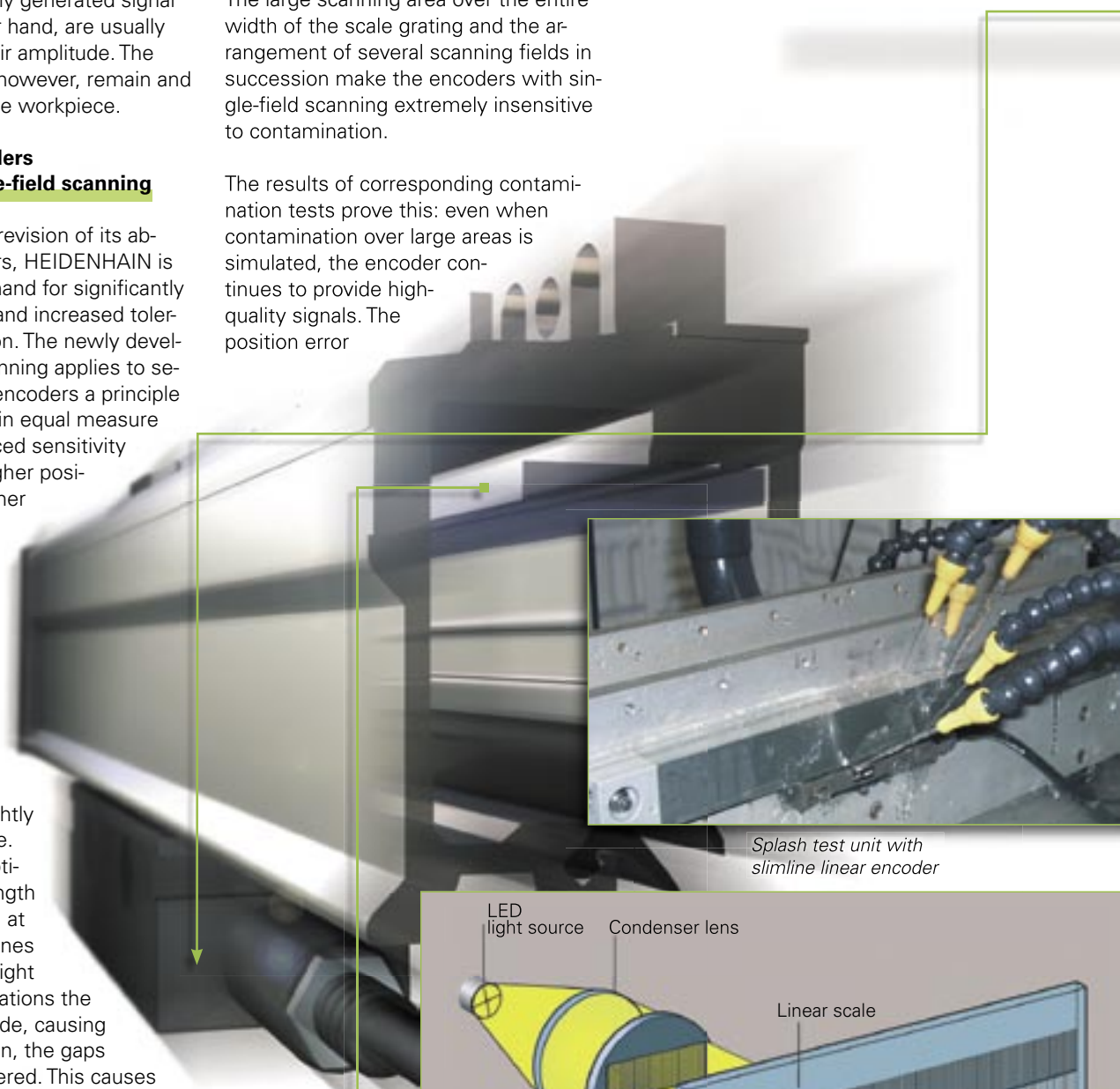

Splash test unit with slimline linear encoder

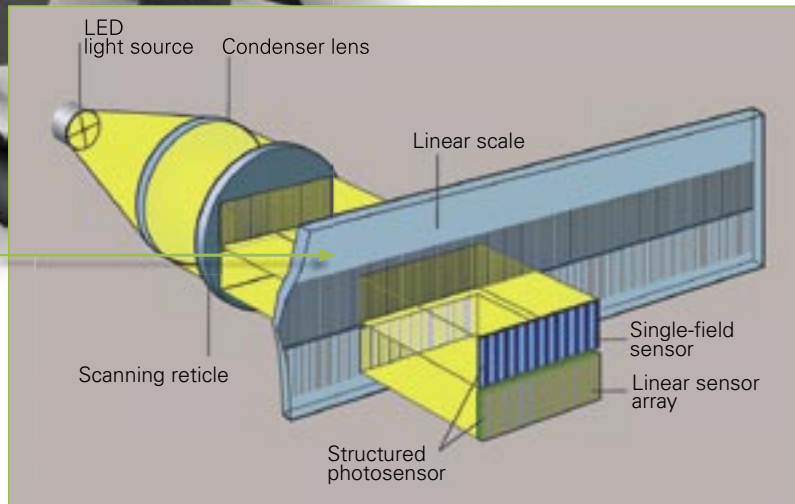

Single-field scanning for absolute linear encoders



remains far below the value specified for the accuracy grade of the encoder. In many cases, depending on the contamination, this can even prevent encoder failure where 4-field scanning cannot.

Higher traversing speeds

Single-field scanning produces signals of high quality and uniformity. Their amplitudes depend only to a small degree on the traversing speed. This guarantees stable output signals for consistently good interpolation, even at high travers-

ing speeds. The linear encoders featuring the new single-field scanning were also improved in design so that now they can operate at traversing velocities up to 180 m/min.

Easy to mount

Machine tools need maintenance, which reduces availability. To reduce downtime it is more important today than ever that all components be very easy to install. This means that it should require only standard tools and short mounting times as well as less time required for adjustment and testing. Linear encoders from HEIDENHAIN are built so that, if the machine has been prepared for it at the design stage with dead stops against pins or shoulders, they can be mounted within minutes.

Conclusion

The demands on modern machine tools for optimization of workpiece quality and productivity are most easily met by using optical linear encoders. System accuracy, thermal stability, high traversing speeds, tolerance to contamination and flexibility in interfacing the control enable their use in all applications. Absolute linear encoders from HEIDENHAIN therefore equally fulfill all requirements. And in this feedback system, future requirements are already accounted for in terms of accuracy and velocity.

Local heating of a ball screw in the traverse range of the ball nut after 6 hours of reciprocating traverse at 24 m/min between two positions separated by 150 mm.

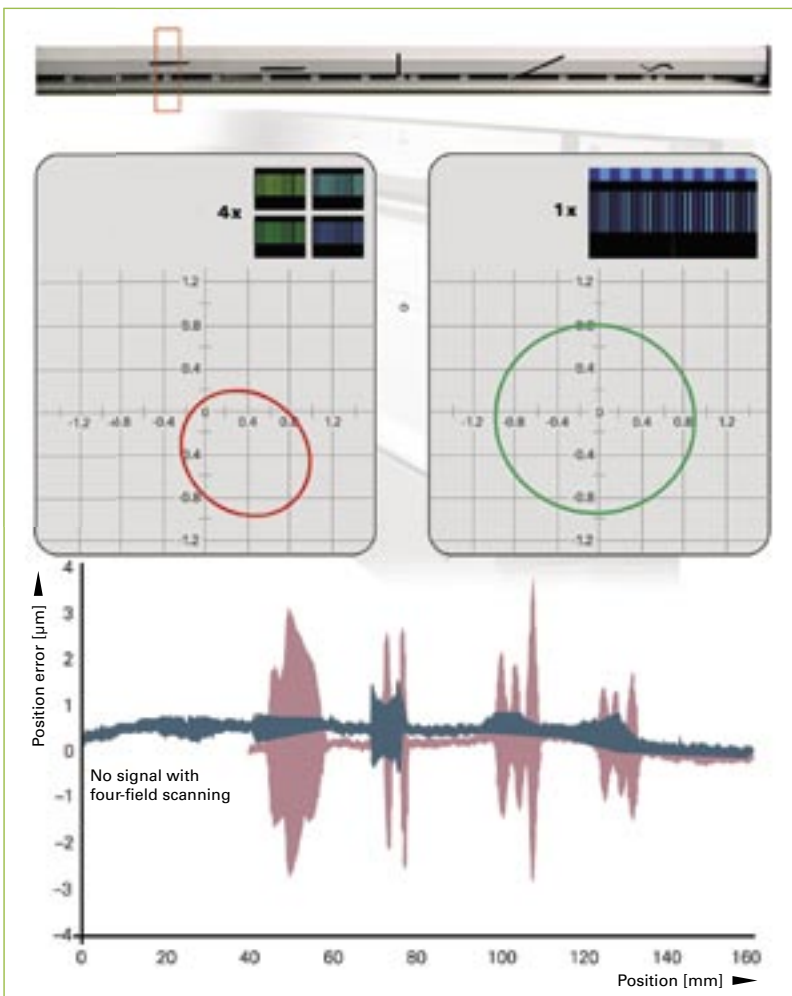

Comparison of signal quality of four-field and single-field scanning with the same contamination

A New, Leaner Touch Probe— The 3-D Infrared TS 440 in Ultra-Compact Design

Up to now, the dimensions of HEIDENHAIN 3-D touch probes have hampered their use in small machines with only limited installation space. The new TS 440 infrared, the TS 640 infrared's little brother, closes this gap with its very compact design. The housing of the TS 440 is 49 mm in diameter and 63 mm in length.

Just like the TS 640, the TS 440 is a triggering 3-D infrared touch probe with a 360° transmission range. In spite of its compact design, the TS 440 has even integrated a blower that cleans the probing point of loose particles with the aid of compressed air or cooling liquids through three jets at the bottom of the probe. This allows automatic measuring cycles during unattended operation. The blaster unit can operate on any machine with a compressed-air or cooling-fluid duct through the spindle.

In its inner life the TS 440 corresponds to the TS 640. An optical switch serves as sensor in which a lens system collimates the light generated from an LED and focuses it as a point of light onto a differential photocell. When the stylus is deflected, the point of light changes its position on the photocell, releasing a trigger signal. Thanks to the non-contacting optical switch the sensor is free of wear. The electronics feature an integrated automatic calibration system (ACS) that ensures excellent long-term stability of the HEIDENHAIN touch probes. The stylus is rigidly connected to a plate integrated in the probe housing on a three-point bearing. The three-point bearing secures the physically ideal resting position and prevents any contortion of the bearing plate from external influences such as vibration.

In this way the stylus always returns to its adjusted position with respect to the spindle axis, which is important for high probing accuracy and repeatability.

Infrared transmission

The TS 440 touch probe transmits the trigger signal over an infrared light beam. This makes it ideal for use on machines with automatic tool changers. The infrared transmission is established between a transmitter/receiver unit (SE 540 or SE 640) and the touch probe.

The infrared beam transmits several types of information. The start signal activates the touch probe. The touch probe acknowledges the start signal with a ready signal. A deflection of the stylus produces the trigger signal. If the touch probe's battery capacity falls below 10%, it transmits a battery warning. The falling edge of the start signal switches the touch probe off again. Switch-on and switch-off by infrared signal enables the touch probe to operate without needing a special taper shank with integrated switch. This benefit makes it possible to easily adapt the touch probe to customized solutions. The LEDs and receiver modules responsible for infrared transmission are evenly distributed on the circumference of the TS 440 and TS 640. This ensures a 360° transmission range for reliable reception without previous spindle orientation. Beyond that, with the SE 640 transceiver the signal can also be transmitted by reflection,

TS 640 and TS 440 infrared touch probes



which means a larger mounting tolerance for the receiver, and above all enables it to function even with swivel heads.

The limits of the transmission range, however, are no obstacle to using the TS 440 in large machines. The new SE 540 transmitter/receiver unit can be used wherever the transmission range of the SE 640 is too short for the application.

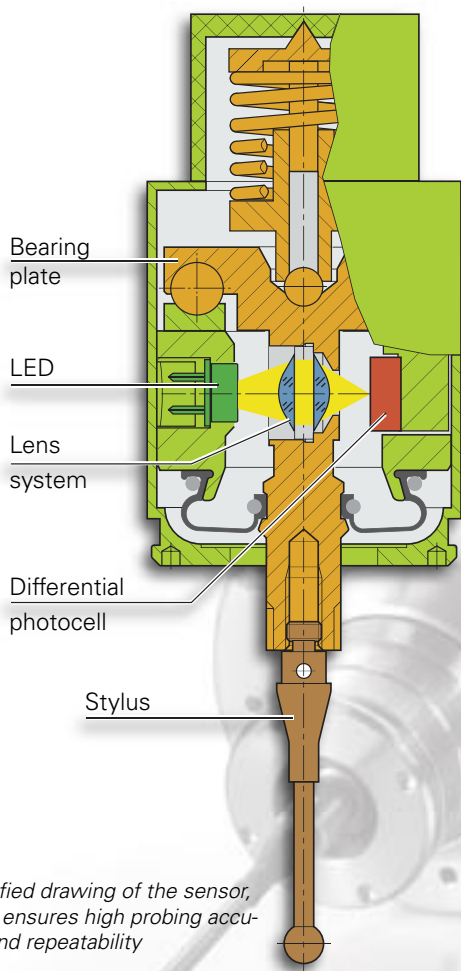

Simplified drawing of the sensor, which ensures high probing accuracy and repeatability

Conclusion

Thanks to their mechanical design and their wear-free optical switch, touch probes from HEIDENHAIN are distinguished by high repeatability and long life spans. The new compact TS 440 makes it possible to exploit well proven technology even in applications that require a small touch probe. Also new is the SE 540 transmitter/receiver unit for application on large machines. Mounting the SE 540 in the spindle head enables reliable transmission of the infrared signals beyond the reception area of the SE 640.

The complete compatibility of the TS 440 and TS 640 three-dimensional touch probe systems with the SE 540 and SE 640 transmitter/receiver units make it possible to adapt them optimally to the respective applications.

SE 540 Transmitter/Receiver Unit

The SE 540 is designed for mounting in the spindle head. Mounting in the spindle head allows the SE 540 to move along with the touch probe to guarantee reliable infrared signal transmission anywhere within the machine's work envelope. This is of great benefit, for example, on very large machines where the complete working space cannot be covered by an SE 640. The SE 540 also ensures reliable transmission in machines with one spindle but two separate working spaces.

The SE 540 features an optical status indicator. A multicolor LED constantly shows the status of the probe (readiness, deflection and battery capacity). All of the electronics are integrated in the compact housing and no additional interface is needed between the SE 540 and the control. The SE 540 can be used with both the TS 440 and the TS 640.

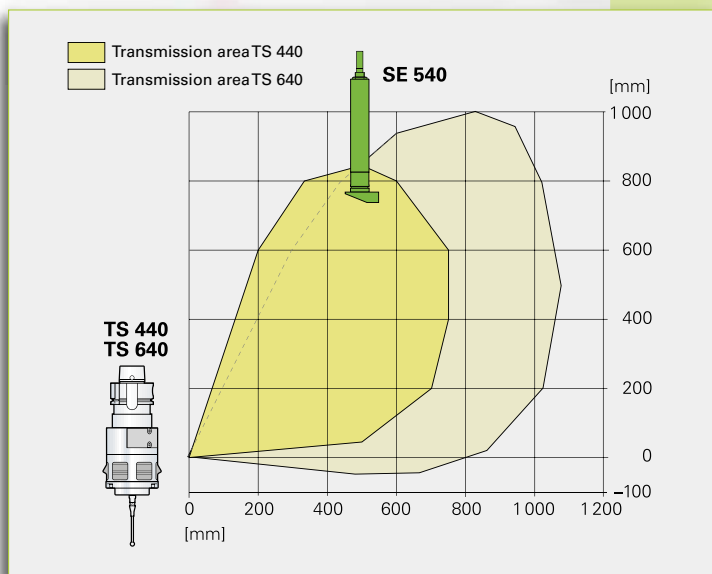
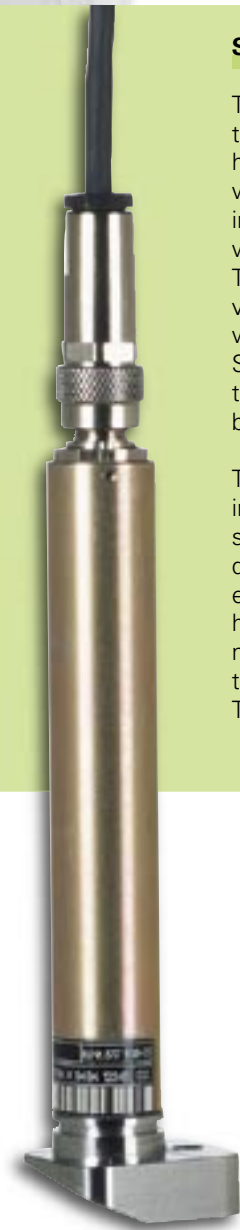

Infrared transmission range of TS 640/TS 440 with SE 540

What Does CNC Technology Have to Do with Building a Fiddle?

CNC instruction at a college-preparatory high school

What makes a college-preparatory high school want to set up a course for CNC programming?

After encouraging experience with a pneumatics course offered in cooperation with the Volkswagen Coaching company of Wolfsburg in the context of a class emphasizing natural science, the Theodor Heuss School started looking for further such opportunities to augment their scientific and technical curriculum. But the purpose of this effort is less to teach specific technical knowledge or skills than to provide a good educational background:

1. The school has a general educational duty. It also includes providing insight into essential industrial and technical manufacturing methods.
2. Workpiece geometry programming is applied mathematics with immediate feedback of the student's results. The workpiece graphics or simulation shows immediately whether the programming strategy, calculations or entered data are correct.
3. In exercises and problems with circles and arcs, students find a fully natural application for polar coordinates, which otherwise are seldom used in school.
4. Problems and tasks can often be solved correctly in different ways. This course offers an opportunity to compare the quality of differing possible and correct solutions while using several criteria—simplicity, inventiveness, length, but also the time needed to complete the programmed workpiece.

For its CNC programming instruction the Theodor Heuss School received from HEIDENHAIN an iTNC 530 programming station with smarT.NC programming capability.

This reveals that in many cases, „correct“ or „incorrect“ are important, but not always sufficient criteria.

The 10th grade students learn to create CNC turning and milling programs, they draft and program special parts (supplemented if possible with aspects of materials science) that are needed for do-it-yourself fiddle building but are too complicated and time-consuming to make with normal woodworking tools, for example the upper and lower shell, neck and pegs. Toward the end of their course the students take their newfound skills and carefully developed workpiece programs to the partner company, transfer their programs to the NC controls on the machines, and watch as their workpieces are manufactured. Students in the 6th grade then build their own fiddles in shop class for use later in a music study group.

In this joint project by the Theodor Heuss School, the VW Coaching Company, and HEIDENHAIN, three partners have pooled their respective strengths:

- A school with professional skills in secondary education and internal advanced training
- A company that can provide machine tools and expert personnel
- An NC control manufacturer that, with the support and instruction of its „multiplier“ personnel, provides impetus, technical expertise, and continued development of the collaboration.

More information on the project is available from Mr. Klaus Papies, Instructor of Physics and Music at the Theodor Heuss School in Wolfsburg, Germany. During a three-week industrial training sabbatical he completed a basic course in TNC programming.



HEIDENHAIN Training Network Expanded

In 2004, HEIDENHAIN succeeded in winning the following new advanced training schools and industrial training institutes as authorized training partners for TNC programming:

Germany

- BTZ Schweinfurt (July 2004)
- TTC Varel, Vareler Hafen (July 2004)
- Mager & Wedemeyer, Oyten (October 2004)

Austria

- WIFI Upper Austria, Linz (October 2004)
- WIFI Salzburg (October 2004)

Asia

- DMG Training Academy Asia, Singapore (September 2004)

South Africa

- Tshwane University of Technology, Pretoria (November 2004)



Now HEIDENHAIN TNC programming courses can be conducted in the following countries in the local language by authorized training partners:

- Austria
- Belgium
- Germany
- Hungary
- Luxembourg
- Singapore
- South Africa
- Switzerland

HEIDENHAIN TNC programming courses can also be taken in the local language from regional HEIDENHAIN agencies of the following countries:

- Belgium
- Brazil
- China
- Czech Republic
- Denmark
- England
- France
- Germany
- Italy
- Netherlands
- Norway
- Portugal
- Singapore
- Spain
- Sweden
- Switzerland
- USA



You can find more information at:
www.heidenhain.de/e0.htm "Training Center"