



**HEIDENHAIN**

59 + 04/2014

# Klartext

News from the World of HEIDENHAIN Controls

## Insights into Practice

How users efficiently  
utilize TNC controls

**Visual:  
Realistic  
graphics for new  
simulation**

**Stop and go:  
Safe retracting and re-  
approaching with the TNC**



# Klartext

59 + 04/2014

## Editorial

### Dear Klartext Reader,

In this Klartext edition we take you into the workshop. Find out how users achieve outstanding results with expertise and commitment. We pay a visit to companies that cost-efficiently produce extremely complex components with the aid of TNC controls. These include for example filigree structures with models for manhole covers, frequently large-dimension components for the aviation industry and injection molds for automotive plastic parts. With the many challenges ranging from setup to tool specification and tool measurement, workers value the simple and concise operation of HEIDENHAIN controls, as well as the possibility of optimizing programs without unnecessary effort. Not everything has to be complicated.

Read and enjoy, with best wishes from the Klartext staff!



*The Müller Modell- und Formenbau company produces complex tools for the injection molding of plastic automotive parts with the iTNC 530—see page 12 for details*



## Production

### Publisher

DR. JOHANNES HEIDENHAIN GmbH  
Postfach 1260  
83292 Traunreut, Germany  
Tel: +49 8669 31-0  
HEIDENHAIN on the Internet:  
[www.heidenhain.de](http://www.heidenhain.de)



# Content

## **TNC 640 supports the creative implementation of cast models**

HEIDENHAIN control simplifies the machining of manhole covers 4

## **Vive la TNC: Performance and precision with very simple operation**

Two successful companies are convinced of HEIDENHAIN controls, and for different reasons 7

## **Convenient stop-and-go**

Reliable retraction and return with the TNC 10

## **More economical 5-axis simultaneous machining with the TNC**

How a mold-maker efficiently produces premium surfaces with a iTNC 530 12

## **A precise view into the universe**

New observation technology with HEIDENHAIN components 14

## **Choosing between premium or functional repair**

New repair plan 16

## **A successful TNC day**

10th CNC Arena Member Meeting 2013:  
Informative views behind the scenes at HEIDENHAIN 17

## **Perfect control with realistic simulation**

New high-performance graphics 18

## **Striding into the future with the TNC 320**

A vocational training facility uses HEIDENHAIN controls 20

## **Further training for production professionals**

The HEIDENHAIN user workshop demonstrates  
strategies that cut processing times 22



### **Responsible**

Frank Muthmann  
E-mail: [info@heidenhain.de](mailto:info@heidenhain.de)  
Klartext on the Internet:  
[www.heidenhain.de/klartext](http://www.heidenhain.de/klartext)

### **Editing and layout**

Expert Communication GmbH  
Richard-Reitzner-Allee 1  
85540 Haar, Germany  
Tel: +49 89 666375-0  
E-mail: [info@expert-communication.de](mailto:info@expert-communication.de)  
[www.expert-communication.de](http://www.expert-communication.de)

### **Photo credits**

A.D.S. International: Page 15  
All other images  
© DR. JOHANNES HEIDENHAIN GmbH

# TNC 640 supports the creative implementation of cast models

HEIDENHAIN control simplifies the machining of manhole covers



***It's all about an innovative design that gets under the wheels of cars: Manhole covers on roads and plazas are sophisticated products that have to assert themselves in the international market. This is shown by the company of ACO Passavant Guss GmbH located in Aarbergen in the Hessian region of Germany and part of the ACO Group, that manufactures drainage systems for the global market. The TNC 640 contour control system for milling and milling/turning machines and HEIDENHAIN machining centers takes on a key role with its optimal integration into the machining process.***

*Today's manhole covers have to save on materials, must be resistant to high loads, must have low noise and be vandal-resistant—and have an attractive appearance as well.*

“You do know what you've achieved,” asked Manfred Kukla, the Managing Director of CIPRO GmbH, paying a complement to the ACO Head of Production Angelika Stein. Less than one year was needed at ACO to establish complete production for positive cast aluminum models. And everything is more or less new: The team, the production expertise, a CAM system and a machining center from matec Maschinenbau, equipped for the first time with the TNC 640 control from HEIDENHAIN.

Today's constructions are characterized by special ideas that have to be rapidly implemented because the manhole covers have to meet ever higher specifications in terms of performance: savings on materials, taking high loads, with low noise and resistance to vandalism. Added to this are custom designs for customers.

The current production process benefits from the strengths of the HEIDENHAIN

TNC 640. To be able to machine the sophisticated models, ACO places its trust in a strategy of designing NC programs directly on the machine. The CAM-generated programs should be optimized with high simplicity in order for example to provide the precondition for good molding processes. This is achieved easily and quickly using HEIDENHAIN structured conversational programs.

## **From a greenfield project to their own model making**

In the beginning was merely the desire to implement their own model production. “We actually began with a greenfield project,” remembers ACO Head of Production Mrs. Stein. During the intensive search for solutions, it was realized that HEIDENHAIN controls fulfilled the requirements best. The intention was to reduce the level of complexity of combined milling and turning with a control that featured easy handling in terms of operation and program creation.





**The strategy of creating NC programs directly on the machine has proven successful. Even complex full-surface machining is efficient.**

A new employee with TNC experience was taken on for the tasks of program creation and machine operation. Benjamin Hejda recommends solutions conceived to exploit the full potential of the new control, and for this purpose, sound knowledge of the control functions and cycles is indispensable. Turning functions though were something new for the new employee. The TNC 640 made it simple for him to get to know the turning functions with continuous operating paradigms, and the manual was available for the details. As a result, only a week was needed following acceptance to produce the first models on the matec 30 HV.

*The TNC 640 simplifies the machining of manhole covers.*

At the beginning of the project a machine made it onto the short list that was optimally designed for milling aluminum models and reworking castings: the matec type 30 HV five-axis machining center with rotary table and swivel head.

To overcome typical barriers in the process sequences and to avoid delays with machine acceptance, a preliminary simulation for the machine and process was enacted. "We went through everything digitally," explained Markus Wagner, CAD/CAM consultant at CIPRO. A post processor was written, matched to the TNC 640, and tools and machining technology for the intended component spectrum was designed together with the tool suppliers. As such, preliminary machine acceptance at matec was the first successful milestone. Final acceptance at ACO was achieved in good time following installation of the EdgeCAM system.



*ACO foundry manager Michael Hahn (left) with his machine operators—HEIDENHAIN makes it easy to handle turning functionality as well as milling.*

*The innovative linking of TNC and CAM: The CXpert software module from CIPRO utilizes the input masks from the HEIDENHAIN control and generates the program in plain language, making it comprehensible for machine operators.*

### Seamless integration with the CAM system

The machining time for a single model can take up to 20 hours. It's in such situations that an interruption-free processing process is desired. Optimizations in the CAM-generated machining program avoid such problems: The program creator adds subprograms at suitable locations that retract components and remove chips, for example. "That's really convenient with the HEIDENHAIN control because I write subprograms as labels and add them very simply into the program via jump labels," explained an enthusiastic Hejda. The situation is similar directly on the machine: If manual contact is needed, ACO is particularly keen on the functions for retracting in the tilted plane and simple re-entry into the machining program.

The CXpert software module from CIPRO is matched to the HEIDENHAIN input dialogs and optimally links the CAM programming to the control. Integration in EdgeCAM simplifies the input process, and all milling and drilling cycles correspond to those of the TNC 640, including support graphics, parameters and support texts. The same is true for the programs created, featuring easily understandable plain-language display. For ACO this simplifies workshop CAM programming and achieves a decisive advantage: Production optimized to time, without having to go through the design loop again.

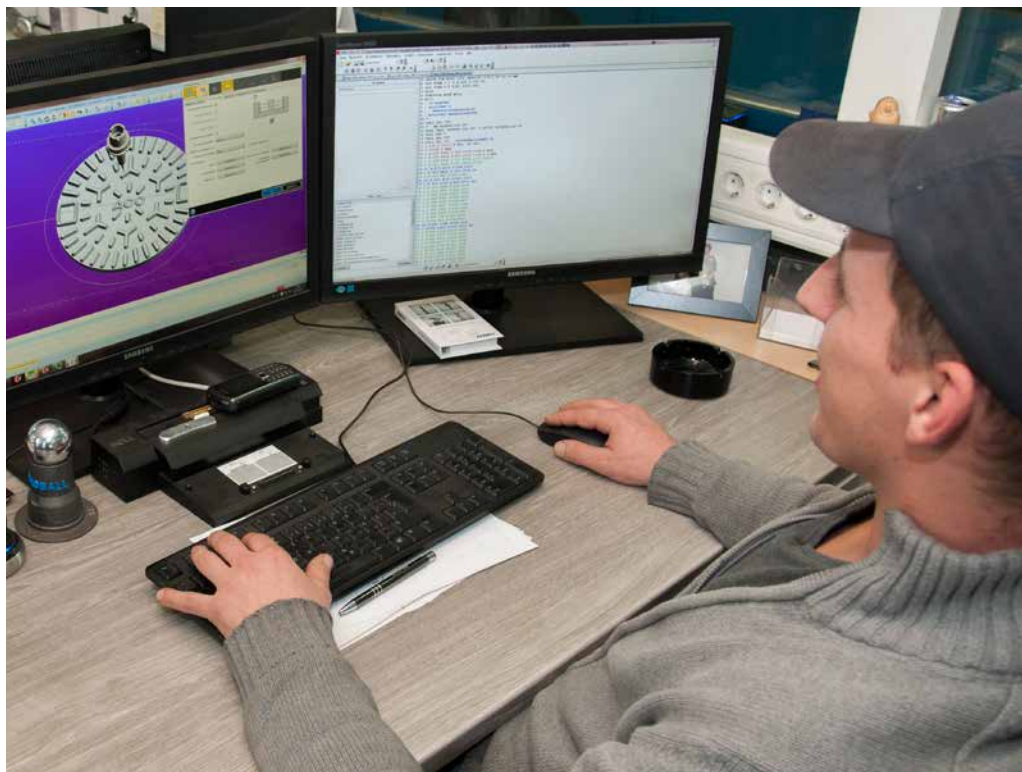

### Making complex milling and turning more simple

The requirements made on model production are oriented to the high demands of new products. These are designed to achieve maximum load capacity with as low a weight as possible, and molding angles and radii are needed so that the models fundamentally have no straight walls. Such requirements can only be met in an economic way and without rework with sophisticated 5-axis simultaneous machining. In such situations a precision level of approximately one tenth is not a problem, it is more a matter of achieving smooth and grooveless surfaces so that during molding the sand does not break away. The machining program is optimized directly in HEIDENHAIN plain language by modifying infeeds and oversizes, for example. Smaller corrections such as adding transition radii and logos are also frequently performed.

An important factor is mastering full-surface machining. Despite increased functionality, the TNC 640 remains true to its concept of comprehensible dialogs and consistent operation for milling and turning functions so that targets are rapidly achieved. This saves time and makes it easy for machine operators to concentrate on their specific production tasks.

### Rapid success with new efficiency

A number of new product launches by ACO prove the new level of performance, and especially critical requirements in terms of weight and costs could be fulfilled. The machine is used to almost complete capacity, and an unmanned third shift was rapidly initiated. The HEIDENHAIN maintenance functions provide a good level of safety, and an SMS is sent when the machine is still.

*Having a look down below is an eye-opener. Walking over a manhole makes it obvious that producing such a cover today assumes complex and efficient processes. In addition to customized designs it's also good to know that traditional companies such as ACO Passavant GmbH can improve their international competitiveness via innovation. It is also thanks to the expertise of partners such as CIPRO and HEIDENHAIN that this is achieved in an unusually short period of time.*

+ ACO Group [www.aco.com](http://www.aco.com)

+ Cipro GmbH  
[www.cipro-gmbh.com](http://www.cipro-gmbh.com)



## Vive la TNC: Performance and precision with very simple operation

Two successful companies are convinced of HEIDENHAIN controls, and for different reasons



***The Klartext team paid a visit to two French component producers: Halgand, a mid-sized company near Nantes, and the French group SUMPARG to the north west of Paris. Both companies have rapidly expanded in the past few years, but the concepts behind their success are completely different. One company focuses on a wide product spectrum and the other on specialized components. One common factor exists, though: Both companies have placed their trust in TNC controls from HEIDENHAIN, with simplicity of operation and highly precise machining results.***

Success is due to different factors: Halgand formerly manufactured mainly aerospace workpieces, but in the meantime the company has strongly expanded its product range and today supplies highly precise components for a wide variety of medical and nuclear technology sectors.

SUMPARG, on the other hand, concentrates exclusively on the aerospace industry, producing parts for aircraft types such as the A380. This in turn requires a machine park suitable for producing complex workpieces to lengths of up to 10 m.

### **TNC in practice: Reliable high performance**

The factors of performance and process safety are important demands made on the control by both companies. Time-intensive machining, as is standard with the large and complex SUMPARG components, demand

intelligent strategies and problem-free processes. To achieve this is essentially the task of the TNC. HEIDENHAIN controls are highly stable in terms of both hardware and software because all components are connected purely digitally via HSCI, the HEIDENHAIN real-time protocol for Fast Ethernet. Process safety is provided by strategies for safe tool change during long machining times and the lift-off function that automatically retracts the tool from the workpiece with program interruption or with line power failure. It's due to these functions that workpieces are not damaged—an essential advantage of the HEIDENHAIN TNC control, because damaged workpieces cannot be repaired in sensitive applications often occurring, for example, in the aerospace industry. "Losing a component that was already maybe 10 or 20 hours in the machining process is simply too great a loss in terms of material and machine time. It's what we have to avoid," explained Loïc Leroy, Managing Director of SUMPARG.

Halgand is highly impressed with the technical performance capability of the TNC: the TNC processors are fast. Complex 5-axis machining processes can as a result be implemented without delays, and the company's own post-processor, created by Halgand himself, ensures tight integration of the existing CAD/CAM systems. Because with Halgand the TNC has been put to use on machines of various manufacturers, for ex-

ample HERMLE, identical components can be produced on differing machines without the necessity of renewed post-processing.

At SUMPAR as well, there are fewer problems with the iTNC during post-processing than with other controls. "The overall performance bears testimony to the TNC," confirmed Alexandre Ducos, Deputy Managing Director of SUMPAR.

### One control for all tasks

At Halgand, the TNC masters a wide variety of orders, whether with small or large dimensions, with aluminum or stainless steel or for 3 or 5-axis machining. Processing is also rapidly programmed on the machine, with the process being supported by extensive control cycle packages. Pre-programmed sequences are also available for typical machining such as drilling, pocket milling and face milling. Parameters are quickly input with the aid of help graphics, thus rapidly creating complete programs. Halgand sees this level of flexibility as being especially important.

The TNC also provides effective solutions for complex contours as well: the high-efficiency SL cycles enable the milling of any pocket or island geometries. The contours are simply defined here in the sub program, and if a contour consists of several subcontours, the 14 CONTOUR cycle superimposes these to create a complete contour.

*The TNC fulfills the high demands that Halgand requires of itself and its products—efficiently producing maximum quality.*



*The level of reliability of the machine and control is an important factor for SUMPAR with long machining times and high material utilization.*



## Contour-precise machining

The TNC at SUMPAR importantly contributes to processing high-precision components with a high level of complexity. Special components for the aerospace industry are produced on 30 machining centers, and it is a consistent challenge to simultaneously produce with rapidity and precision. The TNC controls provide users with the possibility of optimizing precision and speed with motion control.

With machining programs created using CAD/CAM systems, contour deviation can be set in the TNC according to requirements. Cycle 32 is available for this purpose, enabling users to directly influence permitted tolerance and therefore the possible machining speed and achievable surface quality.

The machine implements complex motions as part of 5-axis simultaneous machining. With the TCPM (Tool Center Point Management) function, the TNC compensates for position deviations in linear axes caused by motions of the rotary axes. In addition, the high-efficiency motion control of the TNC ensures that minimum oscillations occur in the machine with direction changes and resultant speed modifications—such oscillations can in turn cause deviations. This ensures that workpieces maintain the predefined tolerance and are nevertheless produced efficiently.

Operation itself remains simple even with complex functions. They naturally benefit from the support and skills of the HEIDENHAIN distributor: LMO company (Sté Lilloise de Machines Outils) which is also in charge of distribution of FPT machines. The Managing Director Loïc Leroy and his deputy Alexandre Ducos agree: "The TNC is much easier to operate than the controls we previously used. That's not just because of the well-structured screen design and clearly designed graphic display—the entire operating approach is superior."

SUMPAR intends to further expand its machine park, which is already mainly equipped with the FPT brand, and is focusing on ever larger machines. At the moment, the company is currently even constructing a specific building for a new machine. And which control will the new machine get? That's an easy one: a TNC from HEIDENHAIN.



*Large-scale, complex components for the aerospace industry are the main business of the SUMPAR Group.*

## Conclusion

The implementation of TNC controls has proven advantageous both at Halgand and for the SUMPAR Group. Both companies appreciate the rapid level of familiarization with the control, simple access to all functions and short paths to targets. "Everything's running"—as underlined by the fact

that the free HEIDENHAIN hotline is hardly ever used. All of this together is a great help in a time of expansion, allowing complete concentration on the processing of orders.

+ [www.halgand.com](http://www.halgand.com)

+ [www.sumpar.com](http://www.sumpar.com)



Do you know this function?

## Convenient stop-and-go

Reliable retraction and return with the TNC

**Program interruptions cost time. If they can't be avoided though, machining should recommence quickly and reliably. On the one hand you want to simply retract the tool, and on the other, continue the machining without problems. In such cases it's good to have a suitable function for practically all situations—as with TNC controls from HEIDENHAIN.**

### After stopping: Convenient retraction and re-approach

When a program interruption occurs, the immediate need is to retract the tool reliably. If you then wish to continue machining, you acknowledge an NC stop with the "manual traverse" soft key. In this way you make sure that the program continues to be referenced and that in the control, for example, the current condition of cycles remains saved. You then simply withdraw the tool using the axis direction key for the tool axis.

An example: If an interruption has taken place during tapping, then simply retract the tool with the press of a button, reli-

ably and completely without problems, because the TNC suitably interpolates the motion of the spindle.

Machining continues: You then bring the tool back to the position before program interruption with the "approach position" soft key.

If the program run does not continue after an interruption, confirm the NC stop with the "Internal stop" soft key. You can then change the operating mode and retract for example in MANUAL MODE—but without the convenient support of the control. Automatic re-approach is then at first no longer possible.

### No misalignment: reliable retraction in the tilted system

In tilted systems, manual tool motions such as retracting are often real challenges. These are no problem, though, with the TNC. With the "3D-ROT" soft key, select whether you wish to

- retract in the tilted coordinate system,
- in the untilted coordinate system,
- or only in the tool axis direction.

Modify the retraction direction at any time as well.

Approach is also flexible with the TNC: With active 3D-ROT function simply select the appropriate axis sequence during the approach run, and change between manual and automatic traverse according to needs.

Thus, in tilted systems, the TNC enables users to be in full control of all situations during approach and retraction.

### Mid-program startup with block scan

Using the "mid-program startup" function (block scan) enables users to reliably start up in mid-program, for example following an internal stop.

- Select the mid-program startup function, and input the block number where the TNC should continue the machining run. The control then simulates the program run until the start-up position, loads all requisite process data and checks whether the correct tool is in the spindle.
- Pre-positioning is started with the "approach position" soft key. The TNC loads the required tool if needed.

Use the mid-program startup whenever the situation requires: Interrupt the approach routine at any time and modify the approach sequence of the axes to adapt the approach direction. This functions both in tilted and untilted condition, and can also be combined with manual approach motions, which is handy when the work space is tight, especially with tilted machining.

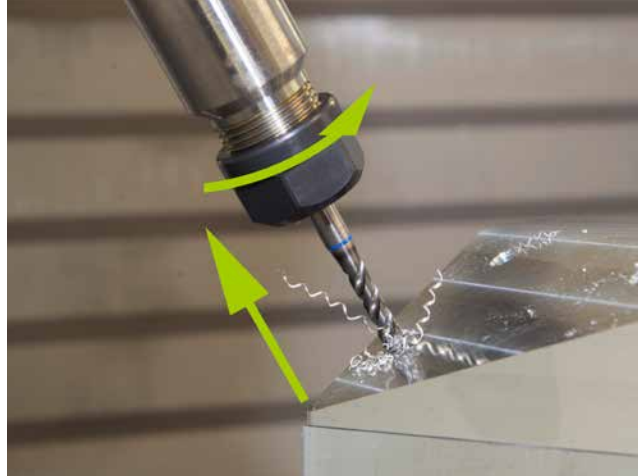

Supported retraction from a thread

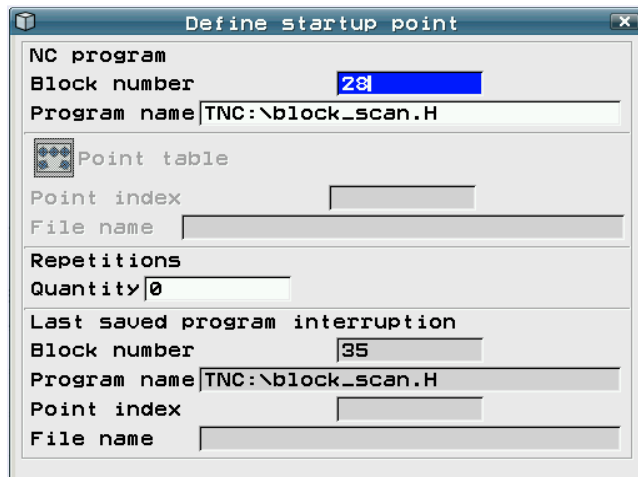

NC mid-program start-up with block scan.

Take note of the following tip before you start: Make sure the start position is approached from the right direction. For this purpose the control must have implemented the position and status before the entered block. Unnecessary tool changes are avoided in the mid-program startup, by the way, when you enter the subsequent block number at which actual machining should begin instead of the number of a TOOL CALL.

### Mid-program start-up in subprograms: Block scan in several steps

Recurring positioning and processing steps are frequently saved in subprograms, and this enables machining programs to be designed more concisely as well as reducing programming effort.

With the example of thread tapping, identical positions are repeatedly approached for centering, core hole drilling and thread cutting.

The control applies the first call of a subprogram when in the block scan you specify a block number located in a subprogram. In the tapping example, the TNC would start at the specified position with

the centering tool. If however the tap is to be used, then the block number with suitable subprogram call would firstly be specified in the block scan.

You should consequently proceed step-by-step if you wish to enter a subprogram:

- Enter the block number that calls the sub program in the input form for the block scan and confirm with NC START.
- Then enter the block number for the machining position into the subprogram via the input form and confirm with NC START.
- Continue positioning with the "approach position" soft key.

This multi-level strategy is suited both for mid-program start-ups in subprograms as well as for specific start-ups in called machining programs. It can also be expanded to any number of steps.

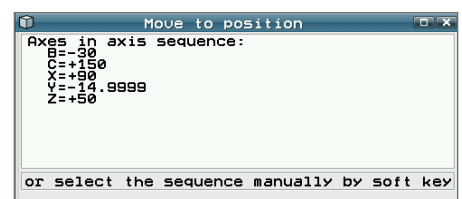

Automatically or manually specifying the axis sequence for positioning



## More economical 5-axis simultaneous machining with the TNC

How a mold-maker efficiently produces premium surfaces with a iTNC 530



***“This control is easily programmed and supports users on multiple levels,” stated a pleased Georg Müller, owner and Managing Director of Müller Modell- und Formenbau GmbH & Co. KG in Biedenkopf-Wallau, Germany. The iTNC 530 from HEIDENHAIN plays a decisive role in achieving perfect surfaces when manufacturing injection molding tools. Müller produces complex tools for the injection molding of plastic automotive parts with 20 machining centers from DMG MORI SEIKI as well as iTNC 530 controls.***

The quality demands of the automotive industry specify the requirements: Interior and exterior components are characterized by high-quality surfaces. “Another thing,” adds Georg Müller, “is that we have to pay attention to plastic parts remaining demoldable, they must be economic to produce and finally also comply with high quality standards.” The manufacture of filigree contours and fine ribs is a particular challenge.

### **High surface quality with TNC controls**

Such requirements are confidently achieved with HEIDENHAIN controls, and the iTNC 530 with its high-precision path and motion control ensures good surfaces. This characteristic of the control guarantees a high level of path precision and also saves any need for high-effort reworking at Müller.

In addition, the behavior of the control can be optimized by using further functions. With the TCPM (Tool Center Point Management) function, the TNC traverses the tool on the contour so that the tool tip during tilting always maintains precisely the same distance to the workplace. The TNC also automatically compensates the offset that the linear axes have to implement. In this way, 3-D machining is continuously run, achieving improved surface qualities.

With the M 120 LOOK AHEAD function, the TNC avoids contour violations that would occur if a contour is milled with radius correction, but smaller radii than the tool radius must be machined. Even with high feed rates, the control calculates the contour a few blocks in advance. With this function the program runs so that locations are omitted for example where the cutter would destroy a smaller radius. In this way, LOOK AHEAD ensures that the first component is also good component.

**“We have to make sure that the molds remain demoldable and that they meet the high quality requirements.”**

**Georg Müller, owner and Managing Director of Müller Modell- und Formenbau GmbH & Co. KG**



*An essential advantage of the HEIDENHAIN control is its simple operation. Each employee bears responsibility for complete machining.*

Müller uses Cycle 32 for a perfect balance of speed and precision, adapted to the DMG MORI SEIKI machines. The cycle determines how precisely the TNC smooths the contour according to surface requirements, and if good surfaces are important, then suitable tolerance for the rotary axes are also set in this way. For high speed cutting runs, the specifically optimal filter settings for roughing and finishing modes are defined in Cycle 32. The operator simply enters the suitable mode in the NC program, meaning that no machine parameters need to be modified.

### TNC supports efficiency

“At the beginning of the 1980s, we switched our production completely to HEIDENHAIN in order to implement employees with a high level of diversity,” explained Georg Müller. He appreciates the simplicity of operation, as the mold makers adapt the NC programs generated from the CAM system on-site on the machine. And this is especially simple with the variety of practical functions provided by the TNC controls. All in all, Müller is able to produce its complex molds highly economically—and usually in one setup.

In Georg Müller's opinion, equipping the machines with HEIDENHAIN controls is

an expression of continuity. “It helps us a great deal when we don't have to relearn each time we get new machines.”

Müller is pleased about continuous order input from the automotive sector, and his company has fundamentally established itself in the market with efficient manufacturing and high quality products.

### Reliable machining with monitoring functions

Müller utilizes the software option Adaptive Feed Control (AFC) for tool monitoring. With machining runs over longer periods or with unmanned shifts, AFC ensures process safety. The iTNC 530 changes a tool when spindle power exceeds a predefined value and at the same time the tool falls below a predefined minimum feed rate. In such cases the tool is probably blunt. The control thus avoids damage to the workpiece that might occur from tool breakage. A further plus is that machine itself is protected.

Müller uses the DCM (dynamic collision monitoring) software option to protect his machines. With the latest machine, a DMU 125 monoBLOCK® NEXT GENERATION, the components were defined that are to be monitored by the iTNC 530. This

also applies to the tools, whether with simple or stepped geometries. When the objects get too near during highly dynamic 5-axis simultaneous machining, the control interrupts the program run. The TNC of course only permits retraction in the direction expanding the distance.

### Conclusion

The company of Müller Modell- und Formenbau is well-known for its efficient production of complex injection-molded tools. The level of technology established in-house contributes to the expertise in which Müller produces initial samples on their own injection-molding machines. “For our customers it's important to get complete service from a single source,” stated the company owner.

The automotive industry appreciates the high quality of the injection molded tools. HEIDENHAIN controls ensure that the molds feature very high surface qualities, thus saving on reworking and rendering production more cost-efficient.

+ [tnc.heidenhain.de](http://tnc.heidenhain.de)  
+ [www.mueller-wallau.de](http://www.mueller-wallau.de)

# A precise view into the universe

New observation technology with HEIDENHAIN components



**Looking at the sky has always fascinated people. Scientists gain knowledge about ever more distant depths of the universe thanks to larger telescopes. The Italian company A.D.S. International supplies components for one of the world's largest telescopes. It's here that HEIDENHAIN ensures maximum precision not only with the functionality of the hexapods but also with production of the components.**

## **On the astronomical instrument: An EQN rotary encoder**

A.D.S. International develops and produces hexapods. These support the platforms for secondary reflectors used in very large-scale telescopes. Their kinematics consist of six actuators, each driven by its own motor.

The positions of the platforms are specified by six absolute rotary encoders from the HEIDENHAIN EQN series, and these measure the lengths and rotation angles with maximum precision and also make sure that the reflectors can be precisely positioned. Daniele Gallieni, General Director of A.D.S. International, is sure: "The extraordinary measuring precision, reliability and long-term stability of HEIDENHAIN rotary encoders achieve unusually good results that meet the whole bandwidth of customer requirements."

## **In the workshop: TNC controls and TS touch probe**

A.D.S. realizes sophisticated customer-specific projects, and this is the reason why the company uses the HEIDENHAIN iTNC 530 control for milling and the CNC PILOT 620 for turning. "In addition to maximum precision and reliability, the controls enable us to implement really quick and convenient modifications during machining," explained workshop manager Enzo Anaclerio. Controls can be flexibly used due to the clearly understandable plain-language dialogs, an important precondition for the rapid production of time-critical components.

A.D.S. uses the HEIDENHAIN TS 640 touch probe for measurements directly in the working space of the machine and in the setup. The advantage is that the detour through the measuring room is not needed and the workpiece remains clamped for possible reworking. In this way, errors are avoided that might be caused by a new setup.

## **On the test bench: The MT length gauge**

A.D.S. places particular importance on the simulation and testing of hexapods in operating conditions that approximate reality as far as possible. Special climate chambers have been installed for this purpose that surround the legs of the hexapods. HEIDENHAIN length gauges from the MT series are used for these testing and calibration tests for reliably testing the stringent performance specifications of customers in the laboratory.

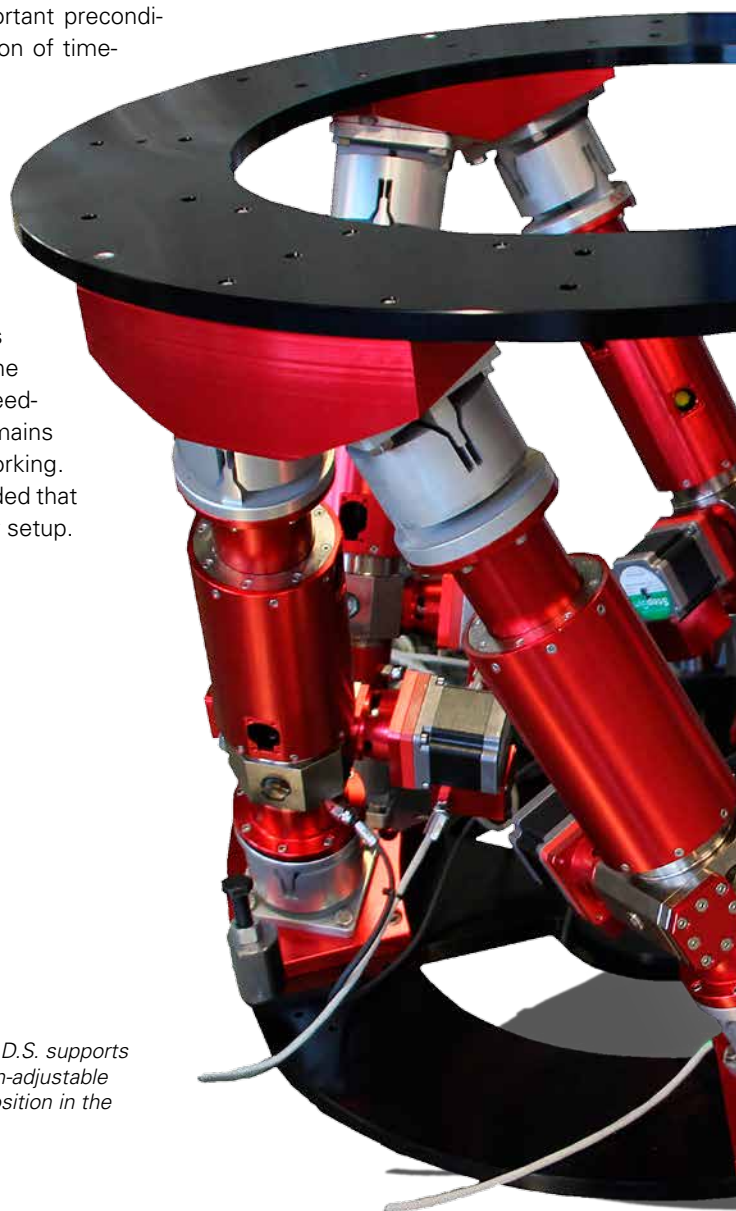

*Movable in all six degrees of freedom: this hexapod from A.D.S. supports telescope reflectors up to a weight of 3,500 kg on six length-adjustable legs. HEIDENHAIN rotary encoders measure the precise position in the space.*

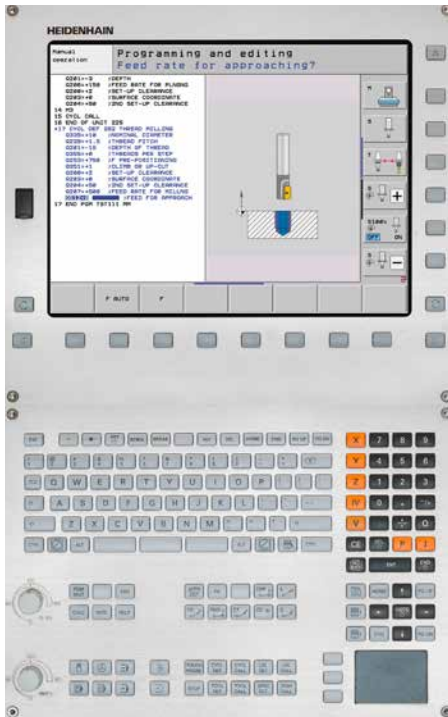

NC programs are created directly on the TNC controls to enable components to be flexibly and rapidly produced with turning, drilling and milling cycles.

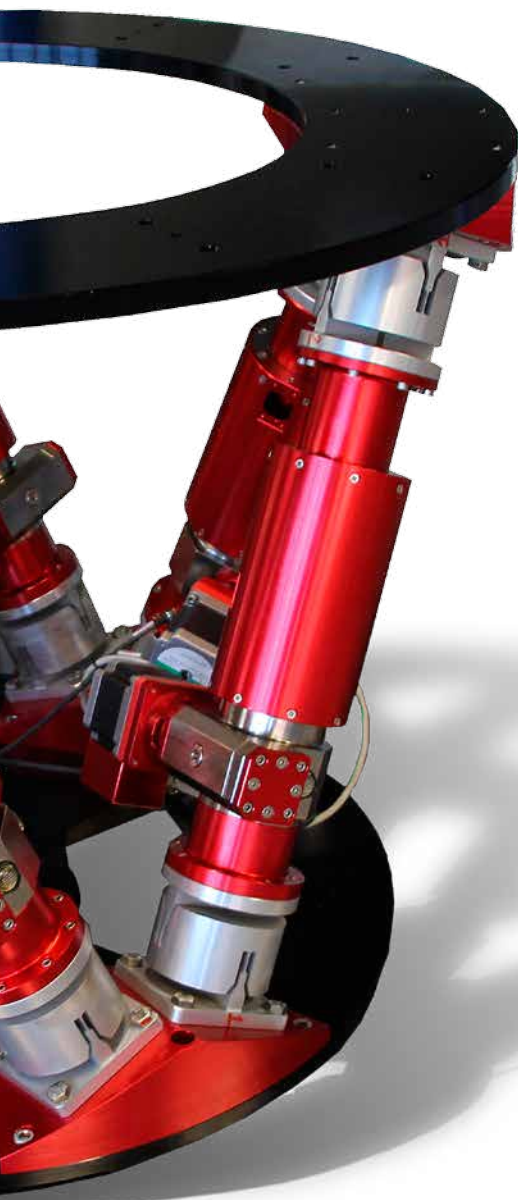

**In application:  
Very Large Telescope (VLT) in Chile**

The hexapod carries out its work with high precision in the Atacama Desert in Chile. The VLT (Very Large Telescope) observatory consisting of a combination of primary and auxiliary telescopes is operated by the European Southern Observatory, and is situated on the Cerro Paranal at a height of 2,600 meters. At this height, en-

vironmental conditions are exceptionally dry and the flow of air very calm—ideal conditions to gaze into the depths of our universe. The HEIDENHAIN components ensure maximum levels of precision for the astronomical instruments from manufacture to operation.

**A.D.S. International**

The company in Valmadrera in the Italian district of Lecco develops, produces and installs astronomical instruments for large-scale telescopes around the world. Each product is unique and designed to meet the specific requirements of the customer. In addition to hexapod development and construction, A.D.S. also programs the control of the parallel kinematics.

+ [www.ads-int.com](http://www.ads-int.com)

# Choosing between premium or functional repair

New repair plan

*When repairing the visible control elements of a machine tool, various requirements exist: Machine producers and dealers often prefer a repair that gives encoders a visibly new condition. This is especially the case when they are stocked in the service warehouse. The users of HEIDENHAIN products on the other hand often want a service that simply restores optimal functionality.*

The new service concept from HEIDENHAIN now takes into account individual requirements more optimally:

- Select the HEIDENHAIN premium repair when both functionality and the visually new condition of the device is to be re-established.
- Specify the HEIDENHAIN functional repair if only problem-free functionality is to be restored. This service version doesn't get rid of traces of use and wear if these do not impair the functionality.

A note can be made on the delivery documents whether customers prefer functional repair or premium repair, and a budget estimate is also possible to help with this decision. This in turn results in a price benefit with servicing.

The new specification option is available from April 2014 for the following products:

- Control keyboard units
- Digital readouts
- Synchronous motors
- Touch probes
- Diverse compact controls

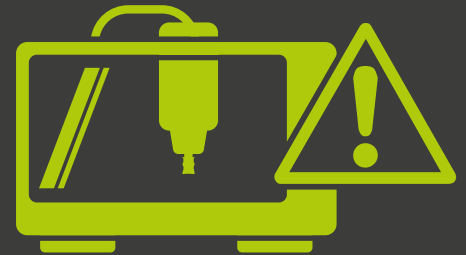

Please address any queries to your HEIDENHAIN service contact partner:  
Tel. +49 8669 1-3121

## You can't wait for a repair?

Then use our HEIDENHAIN service exchange. HEIDENHAIN sends you an exchange unit in premium quality immediately and free of charge. After we've repaired your unit you only have to pay for any repair costs occurring. HEIDENHAIN provides a functional guarantee of one year on the supplied exchange unit.



## Do you already use the HEIDENHAIN help line?

	Telephone	E-Mail
NC support	+49 8669 31-3101	service.nc-support@heidenhain.de
PLC programming for TNC	+49 8669 31-3102	service.plc@heidenhain.de
Encoders / machine calibration	+49 8669 31-3104	service.ms-support@heidenhain.de
Lathe controls	+49 8669 31-3105	service.lathe-support@heidenhain.de
NC programming	+49 8669 31-3103	service.nc-pgm@heidenhain.de

**Business hours:**  
Mon. – Thurs. 8:00 am – 4:30 pm  
Fri. 8:00 am – 3:00 pm

**Standby service:**  
Mon. – Fri. up to 8:00 pm  
Sat. 8:00 am – 6:00 pm

➤ For further information see [service.heidenhain.de](http://service.heidenhain.de)





# A successful TNC day

10th CNC Arena Member Meeting 2013: Informative views behind the scenes at HEIDENHAIN

**The CNC Arena technical portal with its 525 discussion forums provides a platform for the active exchange of information and opinions of users. In the HEIDENHAIN forum of the CNC Arena, users discuss functions and special processing tasks on a daily basis.**

This year the annual member meeting of the CNC Arena took place at HEIDENHAIN in Traunreut, Germany. 70 participants were able to gain tickets, and experienced a day with a diverse program and intensive expert discussions.

The event began with an insight into the HEIDENHAIN product spectrum and a tour of the company, and it was interesting for participants to discover in which branches HEIDENHAIN products are used. Workshops were used to intensify topics such as:

- Optimizing machine precision with KinematicsOpt
- Turning with the CNC PILOT 620
- Probing with touch probes and touch probe cycles
- Roughing with AFC and trochoidal milling
- Mill turning with the TNC 640

Practical applications on machines were demonstrated in the HEIDENHAIN train-

ing center, for example how with a loaded touch probe the machine is measured completely automatically with a touch probe cycle, how simple automatic program generation with TURN PLUS is, and the savings potential to be achieved with materials that are difficult to machine.

The CNC Arena team informed participants about the latest projects and figures as well as awarded the annual CNC Arena Award to a member.

A relaxing brewery restaurant was the location for dinner and leisurely talks during the evening where participants were able to discuss their new knowledge gained throughout the day.

"What we saw and heard was pretty admirable."

"We could see a lot of old and new faces and have some really good discussions."

"An excellent event and lots of information."

"The good thing about events like this is that we're able to look beyond the horizon."

"Questions were answered well, and explanations were also given about what should be observed with certain work processes."



Quotes from the CNC Arena forum.

# Perfect control with realistic simulation

New high-performance graphics

Software version 04

*The new 3-D simulation graphics precisely display the workpiece and provide a significant preview of the actual machining process. Several new view options expose a precise and freely definable view of details. In this way, the TNC helps with the reliable recognition of missing information or problematic machining processes prior to workpiece machining.*

## Perfectly adapting the removal simulation

The meaningful 3-D view is given priority with the removal simulation, and to specifically observe details the user rotates, moves or zooms the view with the mouse or soft keys, as is familiar with CAD systems. Fundamentally, the following views can be selected:

- only the workpiece
- only the tool paths
- the workpiece with tool paths

The TNC customizes the individual information needs of the user with the following display options:

- Blank frame: Displays the original dimensions of the workpiece blank as a frame and shows the primary axes
- Workpiece edges: Renders the facets to support the spatial display.
- Transparent workpiece: Enables a view of inside machining even with rotationally symmetrical workpieces. The following display options make more details visible on the simulated workpiece.
- Display, hide tool, transparent: Shows tools either completely, transparently or not at all so that machining is comprehensible and can be meaningfully displayed in all situations.
- Display workpiece in color: Shows various work steps with different colors. Users can better assign the work steps to the tools used.

## Visually inspecting point distribution

Various resolutions and model types are available for simulating the milling and turning processes. With maximum resolution for 3-D simulation, the control displays the block end points with corresponding block numbers. This facilitates analyzing the point distribution, for example to help in evaluating the expected surface in advance—very useful with externally generated programs.

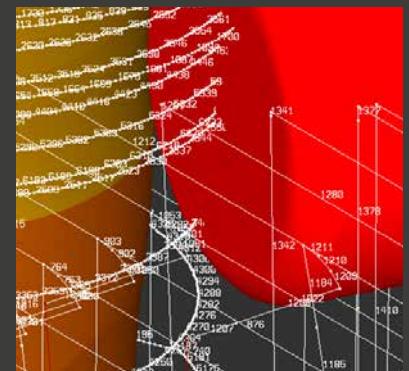

*The display of block end points with block numbers supports the preliminary analysis of surfaces*

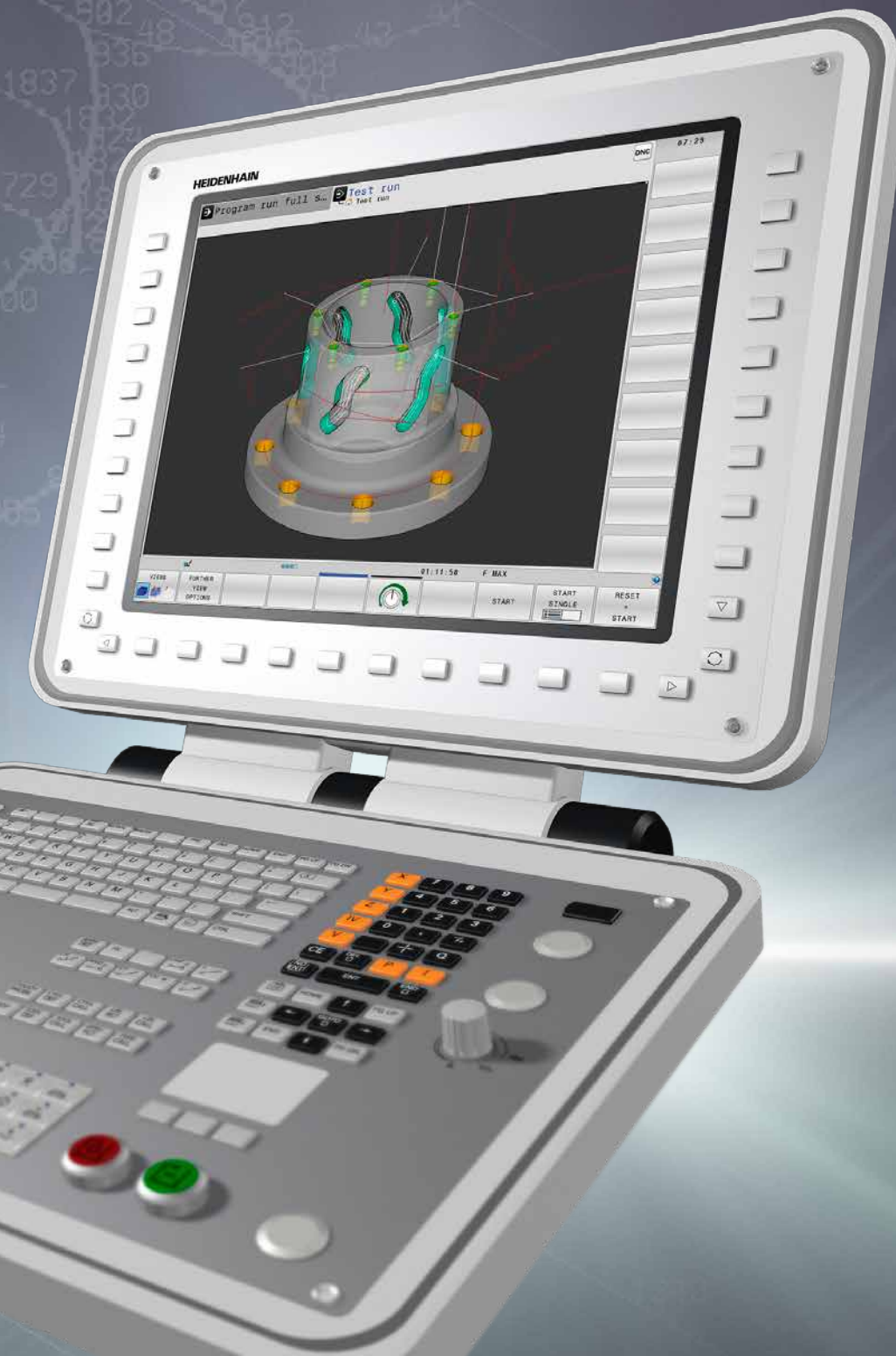

**Realistic previews for milling and turning**

The graphics simulate both milling and turning on workpiece models if these are combined in an NC program. The complex model in the removal simulation shows for example realistic backups as well. The control takes into account the saved machine kinematics.

Removal simulation and workpiece models provide a meaningful preview of the real manufacturing process.

**Soft keys with new order**

The new soft keys are needed due to the new graphics functions. The soft key rows reorder the functions: frequently required functions are accessed via the main bar and the complete functional spectrum is via the submenus.



*Rapid access to frequently needed views*

**Expanded blank definition in software version 04**

The BLK FORM CYLINDER function enables users to define cylindrical workpiece blanks. Specifying the radius and length defines the cylinder, and the inside diameter is specified to create a hollow cylinder.

BLK FORM ROTATION creates a rotationally symmetric blank. The contour description of the cross-section is saved in plain language format in a subprogram.

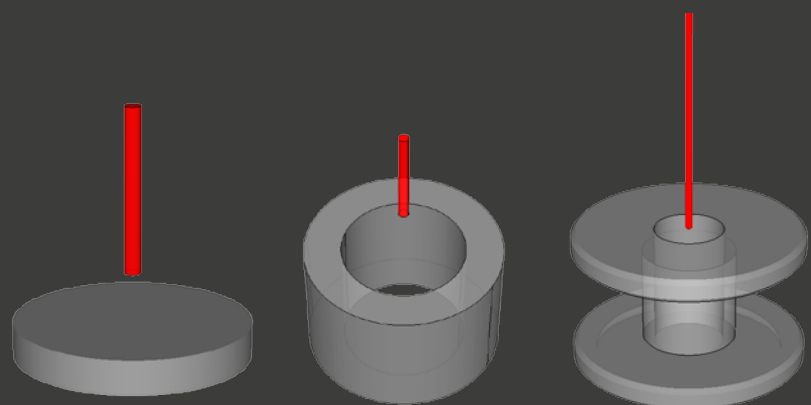

*New forms for blanks: Cylinder, hollow cylinder, rotationally symmetric blanks*



## Striding into the future with the TNC 320

A vocational training facility uses HEIDENHAIN controls

**Quality defines the standards if vocational reorientation should lead to success. A total of 180 employees in the vocational training facility in Munich, Germany are committed to helping people learn a new profession or gaining specific qualifications due to health or social reasons. This is also the case for prospective precision mechanics, who benefit from the advantages of the TNC 320 while undergoing their training over a period of just two years.**

*Highly reliable: HEIDENHAIN position displays have been standard since 1980 on the machines of the vocational training facility.*



### A focus on capabilities and personal interests

People are faced with difficult challenges when they are no longer able to freely practice their profession due to an accident or health reasons. The path back to a working life for many becomes possible only if they are given a chance for professional reorientation—a central task of the Munich vocational training facility. Students benefit from training suited to their own capabilities and aptitudes and personal interests are taken highly seriously. These are in fact important preconditions for a professional restart with a high level of motivation.



### HEIDENHAIN commitment supports optimal training

The 27 possible training vocations at the center include precision mechanics and industrial mechanics. A connection to the profession in practice is an important part of the training, and the Munich facility places priority on bringing together theory and practice, training both under a single roof. This is the reason why students benefit from a training location equipped with a variety of turning and milling machines sourced from renowned manufacturers. The new HEIDENHAIN controls and position displays fit well into this environment.

The students learn to fundamentally handle machine tools, trying out machining strategies and gaining experience with materials and tools. Many of the machines were equipped

*Close to practice: the vocational training center uses machines and controls that the students will be using in companies after their training is completed.*

*Modern: The center has lifted their training to the state of the art with the HEIDENHAIN TNC 320.*

or upgraded with HEIDENHAIN ND 780 position displays and linear encoders. This enables workpieces to be produced with high precision on the manually controlled machines. This is highly relevant for working in practice because manual machine operation is common in many companies.

Operating modern CNC controls for machine tools is also an important component of training, and students must have up-to-date knowledge for their future workplaces. It's for this reason that the center has equipped its 3-axis milling machines with HEIDENHAIN controls, and the workshop supervisor is highly proud of the two new TNC 320 controls. The control concisely displays the complete spectrum of information required for program creation and operation on the 15" screen. A variety of practical cycles also provide support for standard machining and with complex applications.

Training as a precision mechanic is achieved in a relatively short time period. HEIDENHAIN controls with their easily understood plain language dialogs and high



*Committed: The supervisors in the vocational center in Munich give their very best for individual students, from left to right: Horst Weindl, Manfred Schäffler, Peter Wagner and Hubert Zenz.*

level of operating convenience significantly contribute to this. "Our students handle the HEIDENHAIN control really well," emphasized the trainer Hubert Zenz. "The operation itself is very clear and simple." This enables the future professionals to optimally concentrate on their machining tasks. They should of course also benefit from practically trying out the options and important functions of a modern control.

Proof of the high standard of training is provided by a glimpse into the glass display cabinet of the training facility—many workpieces and complex mechanical assemblies underline the successful level of knowledge transfer.

### A quality partnership

The Munich vocational training facility has been working since 1980 with HEIDENHAIN position displays. Since that time, new machines with the latest position displays have been continuously installed or older machines upgraded. With HEIDENHAIN programming stations and three new TNC 320 controls, the vocational center benefits from the latest state of technology. The training supervisor Jochen Kunert praises the successful cooperation with the experts from Traunreut and is pleased about their direct and highly active support.

*Highly motivated: The up-and-coming precision mechanics are trained to become sought-after experts over a period of two years.*

### Munich vocational training facility

The vocational training center in Munich is a charitable and industry-wide facility. It trains people with need for support due to health or social reasons, enabling them to once again take up professional life. The spectrum of training services offered ranges from vocational reorientation to partial qualifications and complete retraining with a suitable qualification by the appropriate professional body, and integration into a professional working vocation.

+ For details see:  
[www.bfw-muenchen.de](http://www.bfw-muenchen.de)



# Further training for production professionals

The HEIDENHAIN user workshop demonstrates strategies that cut processing times

**Participants squeezed together to get a good look at the milling machine. What was happening in the machine room was certainly impressive. The form began to take shape in next to no time, and all the theories from that morning's technical lectures could now be seen in practice. The specialists were suitably impressed during the 2nd user workshop organized by HEIDENHAIN at the end of October 2013 in their Traunreut training center.**

According to the motto of the "1-2-3 process chain," participants who had come to the workshop gained practical insights about how to save significant time during roughing, and with two application examples the workshop demonstrated a variety of optimization options. Three components were used in the process: The CAM software hyperMILL from OpenMind, the simulation software VERICUT from the company of CGTech and the HEIDENHAIN iTNC 530 and TNC 640 controls.

## Step-by-step optimization

At the beginning was the CAM software. HyperMILL generates paths for 5-axis machining with the new hyperMAXX® roughing strategy. The strategy utilizes the trochoidal milling process whereby machining is implemented with trochoidal tool paths. hyperMAXX® avoids complete cuts and abrupt direction changes to ensure homogeneous putting conditions.

Highly suitable for this is a newly developed, high-performance barrel-shaped cutter from EMUGE. Participants witnessed how uniformly and rapidly the material was removed, which in turn significantly improves process stability.

The simulation software VERICUT utilizes the NC program generated in the CAM system and ensures its high quality and precision—the software interactively simulates the material removal process. It also adapts feed rates to actual cutting conditions to accelerate the machining process and simultaneously ensure constant cutting pressure. VERICUT also optimizes the traverse paths to improve the safety clearances and avoid blank runs. As a result, tool life is significantly extended.

HEIDENHAIN also demonstrated to participants how the machining time can be further reduced during the last stage of the process chain. Users can get things moving even more simply and directly with the TNC control: The ratio of machining speed and precision is defined in Cycle 32 TOLERANCE—the tolerance value for roughing was increased to distinctly cut down on machining time.

- + Information about HEIDENHAIN training courses: [training.heidenhain.de](http://training.heidenhain.de)
- + Information about workshop partners: [openmind-tech.com](http://openmind-tech.com), [cgttech.de](http://cgttech.de)

Workshop participants became familiar with a new development: The barrel-shaped cutter from EMUGE machined the cavities of the workpiece extremely quickly. Coordinated to the hyperMAXX® roughing strategy, the special barrel-shaped form achieved better results in a shorter time compared to ball cutters.

*A complex aluminum (AlMgSi1) rim was created with the TNC 640. The dependable fixture technology was highly important.*





*Production close-up: Workshop participants found out how much machining time can be saved when they optimize in the right places.*

Participants in the machine hall of the HEIDENHAIN training center experienced a situation that exploited the complete range of optimization possibilities: Correct selection of the suitable machining strategy with the CAM software, optimizing the feed rates with Optipath and specifying the best-possible tolerance settings in Cycle 32 on the control. This aroused a good deal of enthusiasm with all participants.



*In the workshop the form for a respiration mask was machined with the iTNC 530 HSCI. A challenge was the material itself: A corrosion-resistant plastic mold steel 1.2083.*

## User workshop: Milling and turning in one setup

The next user workshops will be taking place on 21/22.05.2014 in the training center at Traunreut. Expert partners from the production technology sector will be showing their products:

- Innovative CAD/CAM applications, Tebis
- Highly modern cutting tools, Ingersoll Werkzeuge
- Complex fixtures, SCHUNK
- HERMLE 5-axis machining center C42 MT with HEIDENHAIN TNC 640

**+ Details and online registration:**  
[training.heidenhain.de/schulungsprogramm](http://training.heidenhain.de/schulungsprogramm)

This workshop will be taking place on 25. and 26.06.2014 in the demonstration center of the machine manufacturer Berthold Hermle AG in Kassel-Lohfelden, Germany. Register via mail at [info@hermle.de](mailto:info@hermle.de).



# HEIDENHAIN

## dynamic + efficiency

Sometimes you have to bundle all your forces to achieve your goal. This truth is no more valid in sports than it is in chip making on milling machines. Here the TNC control from HEIDENHAIN provides "Dynamic Efficiency" to find the potential hiding in your machine: for example higher metal removal rates with Active Chatter Control (ACC) combined with Adaptive Feed Control (AFC). With "Dynamic Efficiency" you become more productive, spare your machine, and attain longer tool service life.

DR. JOHANNES HEIDENHAIN GmbH, 83292 Traunreut, Germany, phone +49 8669 31-0, [www.heidenhain.de](http://www.heidenhain.de)

angle encoders + linear encoders + contouring controls + position displays + length gauges + rotary encoders